

STANDARD NO-HUB COUPLING

Part #	Model #	Description (Size)	SS CLAMPS	Inner Carton Qty	Master Carton Qty	Select Model Below
STANDARD NO-HUB COUPLINGS						
H99900	HPNHC112	1-1/2" x 1-1/2" NO-HUB COUPLING	2	1	100	<input type="checkbox"/>
H99901	HPNHC2	2" x 2" NO-HUB COUPLING	2	1	100	<input type="checkbox"/>
H99902	HPNHC2112	2" x 1-1/2" NO-HUB COUPLING	2	1	100	<input type="checkbox"/>
H99903	HPNHC3	3" x 3" NO-HUB COUPLING	2	1	100	<input type="checkbox"/>
H99904	HPNHC4	4" x 4" NO-HUB COUPLING	2	1	100	<input type="checkbox"/>
H99905	HPNHC5	5" x 5" NO-HUB COUPLING	4	1	20	<input type="checkbox"/>
H99906	HPNHC6	6" x 6" NO-HUB COUPLING	4	1	25	<input type="checkbox"/>
H99907	HPNHC8	8" x 8" NO-HUB COUPLING	4	1	15	<input type="checkbox"/>
H99908	HPNHC10	10" x 10" NO-HUB COUPLING	6	1	12	<input type="checkbox"/>
H99909	HPNHC12	12" x 12" NO-HUB COUPLING	6	1	8	<input type="checkbox"/>



TECHNICAL INFORMATION

MATERIAL SPECIFICATION

PART	MATERIAL	SPECIFICATION
1 Shield	Stainless steel	AISI 300
2 Band clamp	Stainless steel	AISI 300
3 Worm gear screw -- 5/16" hex-head	Stainless steel	AISI 300
4 Worm gear cover	Stainless steel	AISI 300
5 Gasket	Neoprene rubber	ASTM C564-2014

CERTIFICATIONS / LISTINGS

ASTM C1277: Standard specification for shielded couplings joining hubless cast iron and soil pipe and fittings.

CSA B602: Mechanical couplings for drain, waste and vent pipe and sewer pipe

CISPI 310: Specification for coupling for use in connection with hubless cast iron, soil pipe and fittings for sanitary and storm, waste, and vent piping applications.

IAPMO UPC and **NSF** Certified

Note: For tightening bands, incrementally tighten the 5/16" Hex-Head/Shoulder Screws to 60 Inch/Pound with a calibrated torque wrench to assure even compression and seating.

SEE ADDITIONAL PAGES FOR TECHNICAL DRAWINGS

JOB NAME:

JOB LOCATION:

CONTRACTOR:

DATE:

ITEM TAG:

ENGINEER APPROVAL:

DATE:

PART NUMBER:

1-1/2" STANDARD NO-HUB COUPLING

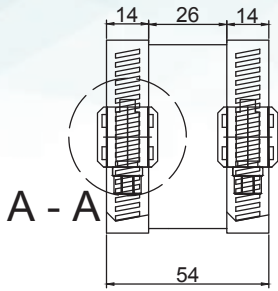

Pictured Left:
1-1/2" standard no-hub,
front view

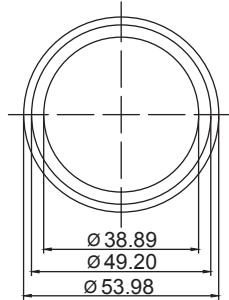

Pictured Below:
1-1/2" No-Hub band clamp detail

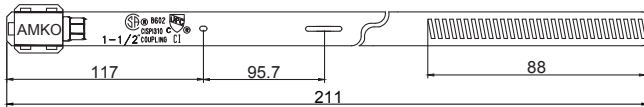

Pictured Below:
Heavy-duty band clamp detail



Pictured Below:
1-1/2" standard no-hub
gasket, cut-away view

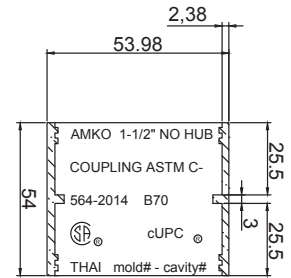

2" STANDARD NO-HUB COUPLING

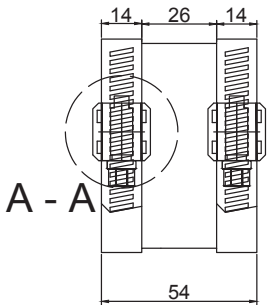

Pictured Left:
2" standard no-hub,
front view

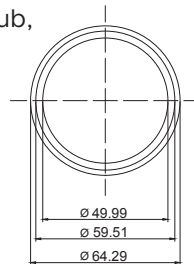

Pictured Below:
2" No-Hub band clamp detail

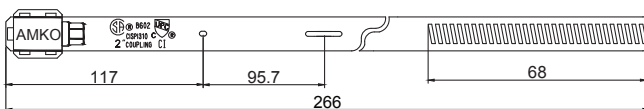

Pictured Below:
Heavy-duty band clamp detail

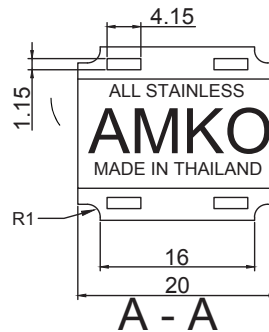

Pictured Below:
2" standard no-hub
gasket, cut-away view

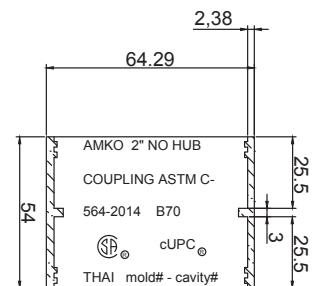

JOB NAME:

JOB LOCATION:

CONTRACTOR:

DATE:

ITEM TAG:

ENGINEER APPROVAL:

DATE:

PART NUMBER:

2" x 1-1/2" STANDARD NO-HUB COUPLING

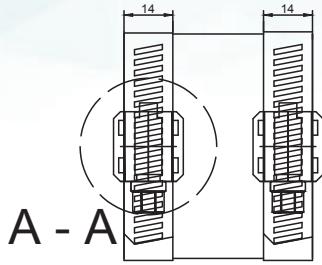

Pictured Left:
2" x 1-1/2" standard no-hub,
front view

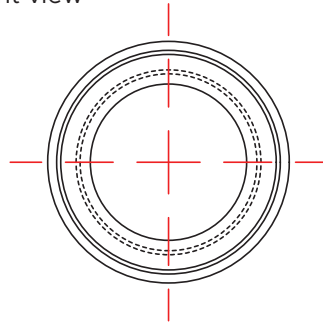

Pictured Below:
Heavy-duty band clamp detail

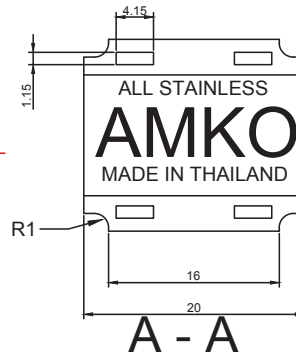

Pictured Below:
2" x 1-1/2" standard no-hub
gasket, cut-away view

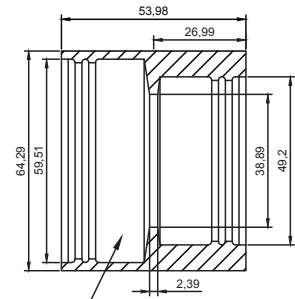

Pictured Below:
2" x 1-1/2" No-Hub band clamp detail

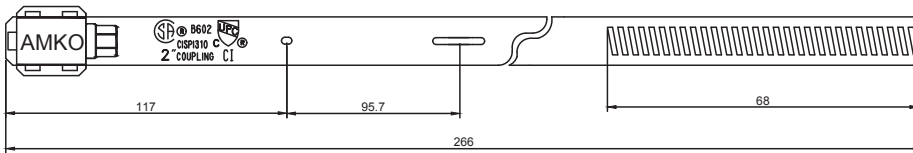

AMKO 2"X1-1/2" NO HUB COUPLING ASTM
C-564-2014 B70
THAI mold# - cavity#

3" STANDARD NO-HUB COUPLING

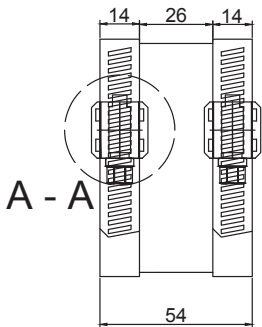

Pictured Left:
3" standard no-hub,
front view

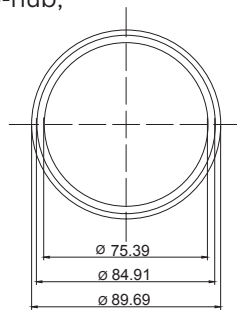

Pictured Below:
Heavy-duty band clamp detail



Pictured Below:
3" standard no-hub
gasket, cut-away view

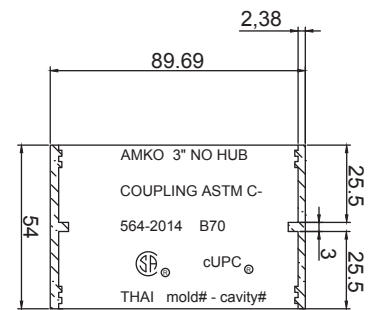

Pictured Below:
3" No-Hub band clamp detail

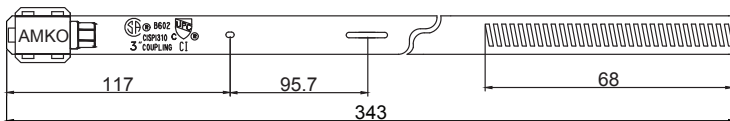

JOB NAME:

JOB LOCATION:

CONTRACTOR:

ENGINEER APPROVAL:

DATE:

DATE:

ITEM TAG:

PART NUMBER:

4" STANDARD NO-HUB COUPLING

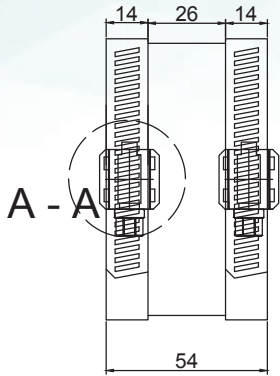

Pictured Left:
4" standard no-hub,
front view

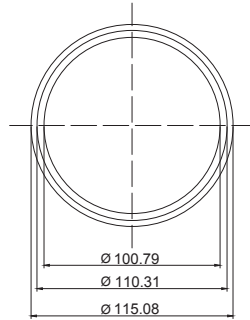

Pictured Below:
Heavy-duty band clamp detail

Pictured Below:
4" standard no hub
gasket, cut-away view

Pictured Below:
4" No-Hub band clamp detail

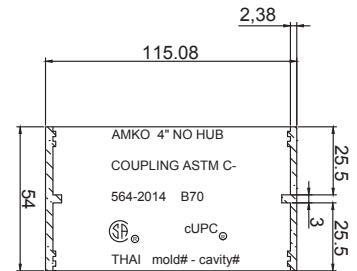
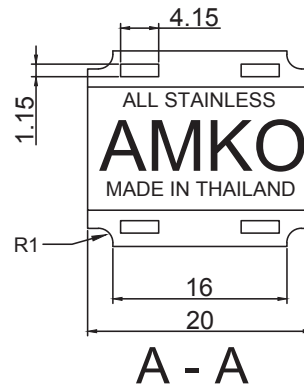
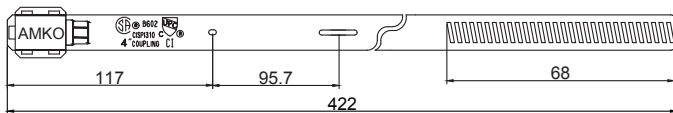

5" STANDARD NO-HUB COUPLING

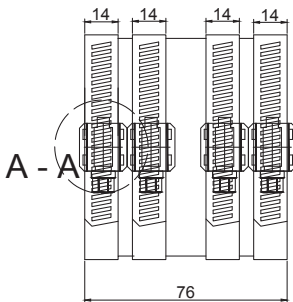

Pictured Left:
5" standard no-hub,
front view

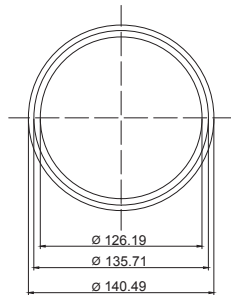

Pictured Below:
Heavy-duty band clamp detail

Pictured Below:
5" standard no-hub
gasket, cut-away view

Pictured Below:
5" No-Hub band clamp detail

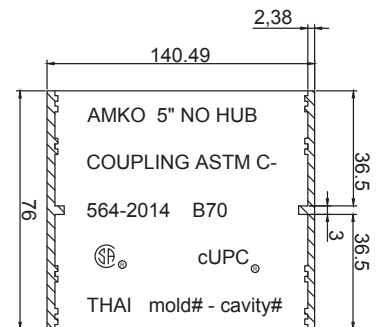
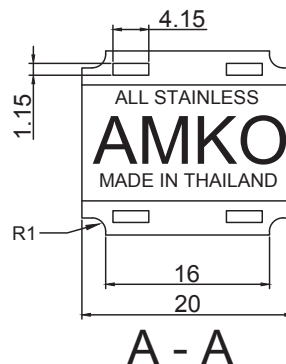
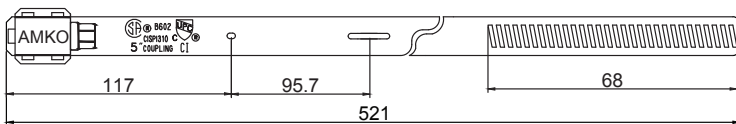

JOB NAME:

JOB LOCATION:

CONTRACTOR:

ENGINEER APPROVAL:

DATE:

DATE:

ITEM TAG:

PART NUMBER:

6" STANDARD NO-HUB COUPLING

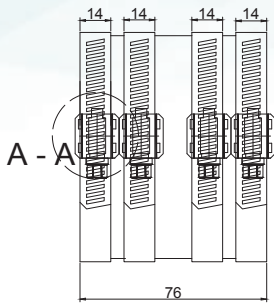

Pictured Left:
6" standard no-hub,
front view

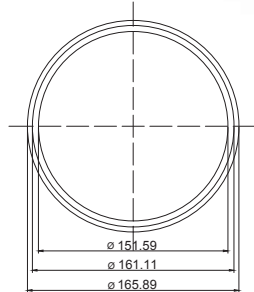

Pictured Below:
Heavy-duty band clamp detail

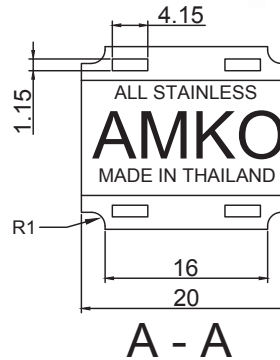

Pictured Below:
6" standard no-hub
gasket, cut-away view

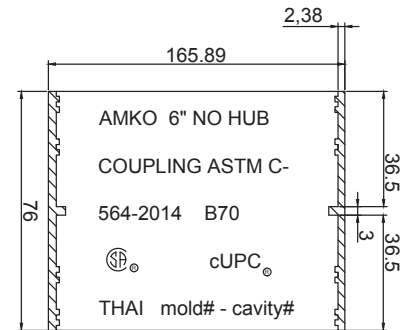

Pictured Below:
6" No-Hub band clamp detail

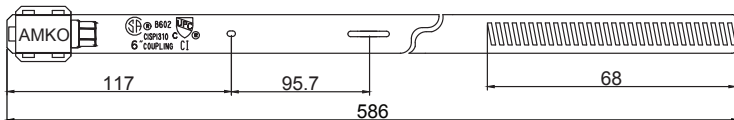

8" STANDARD NO-HUB COUPLING

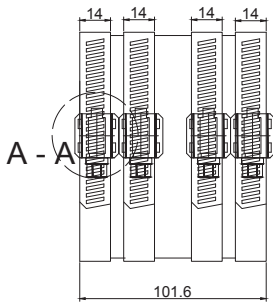

Pictured Left:
8" standard no-hub,
front view

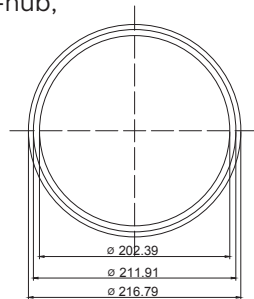

Pictured Below:
Heavy-duty band clamp detail

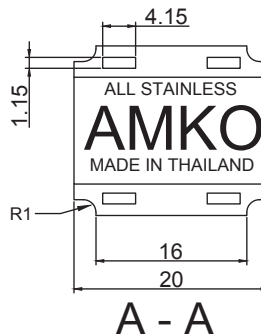

Pictured Below:
8" standard no-hub
gasket, cut-away view

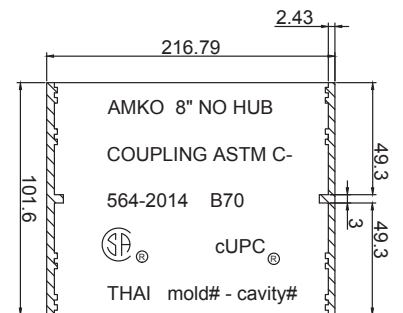

Pictured Below:
8" No-Hub band clamp detail

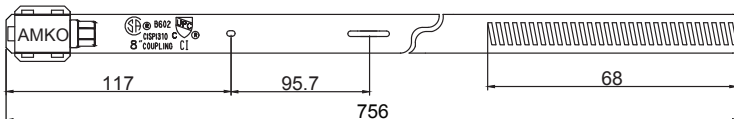

JOB NAME:

JOB LOCATION:

CONTRACTOR:

ENGINEER APPROVAL:

DATE:

DATE:

ITEM TAG:

PART NUMBER:

10" STANDARD NO-HUB COUPLING

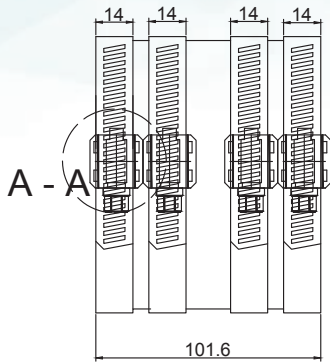

Pictured Left:
10" standard no-hub,
front view

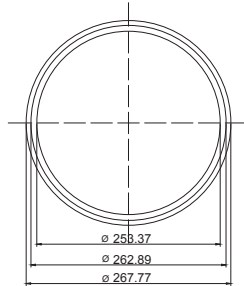

Pictured Below:
Heavy-duty band clamp detail

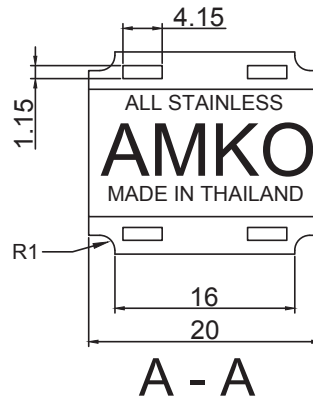

Pictured Below:
10" standard no-hub
gasket, cut-away view

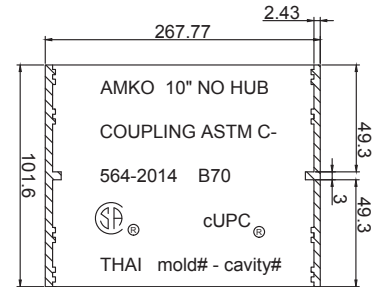

Pictured Below:
10" No-Hub band clamp detail

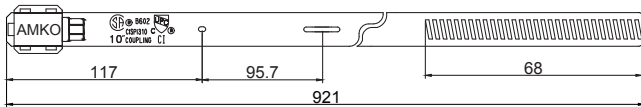

12" STANDARD NO-HUB COUPLING

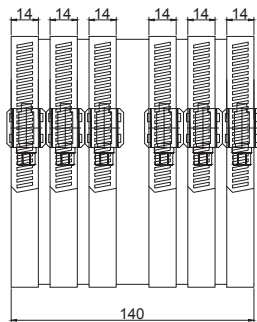

Pictured Left:
12" standard no-hub,
front view

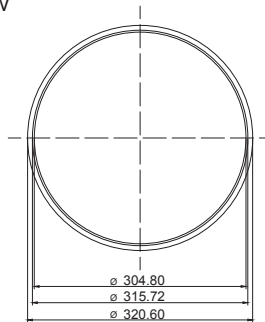

Pictured Below:
Heavy-duty band clamp detail

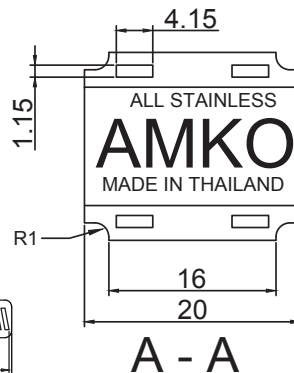

Pictured Below:
12" standard no-hub
gasket, cut-away view

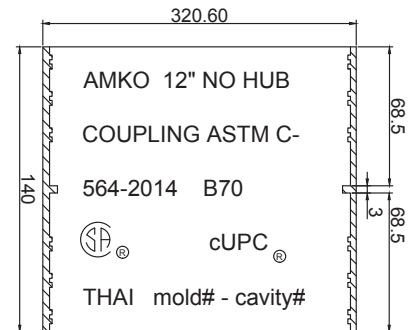

Pictured Below:
12" No-Hub band clamp detail

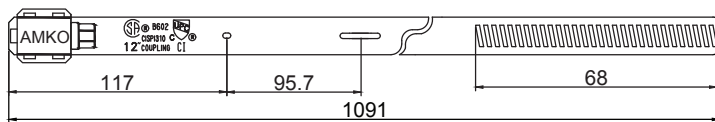

JOB NAME:

JOB LOCATION:

CONTRACTOR:

DATE:

ITEM TAG:

ENGINEER APPROVAL:

DATE:

PART NUMBER: